

Commitment Approval

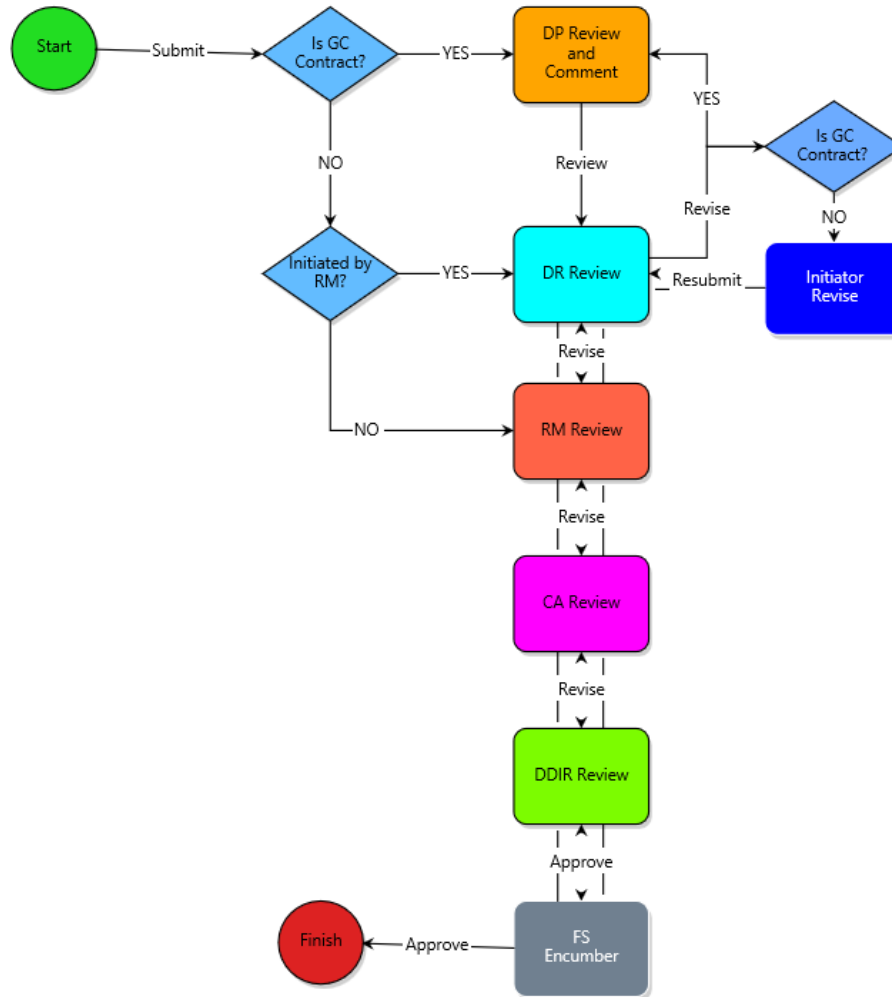

Commitment Change

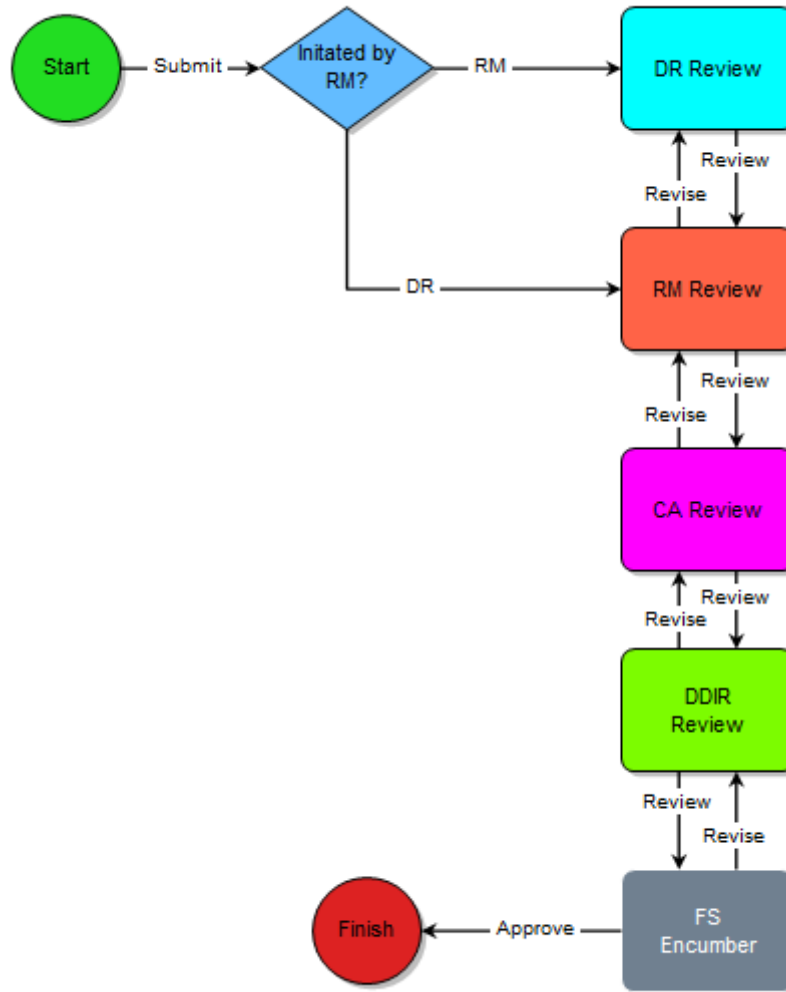

Owner Design Review

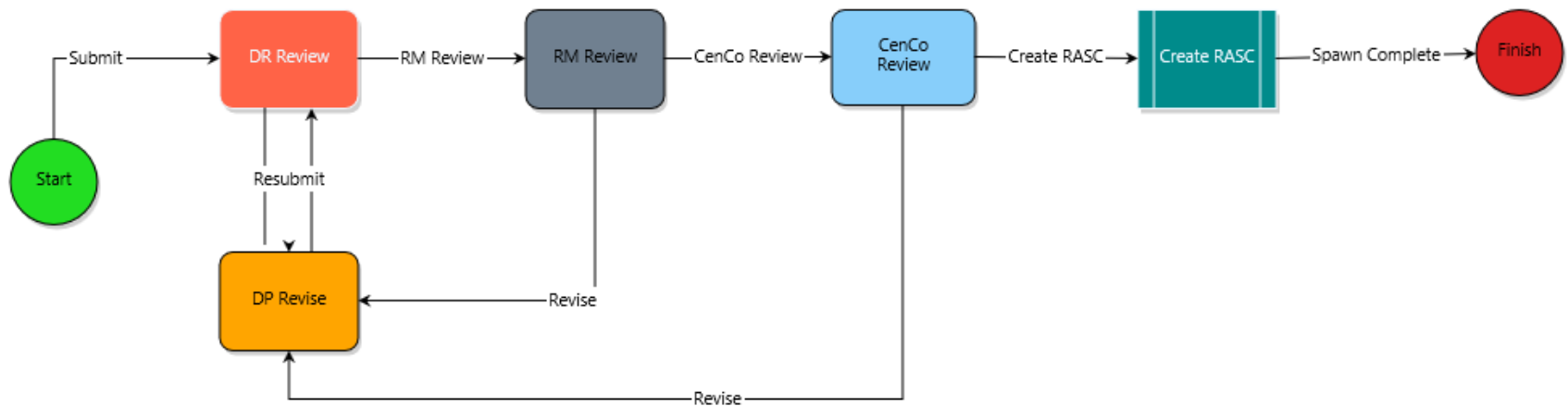

Request for Approval of School Construction (PSCOC)

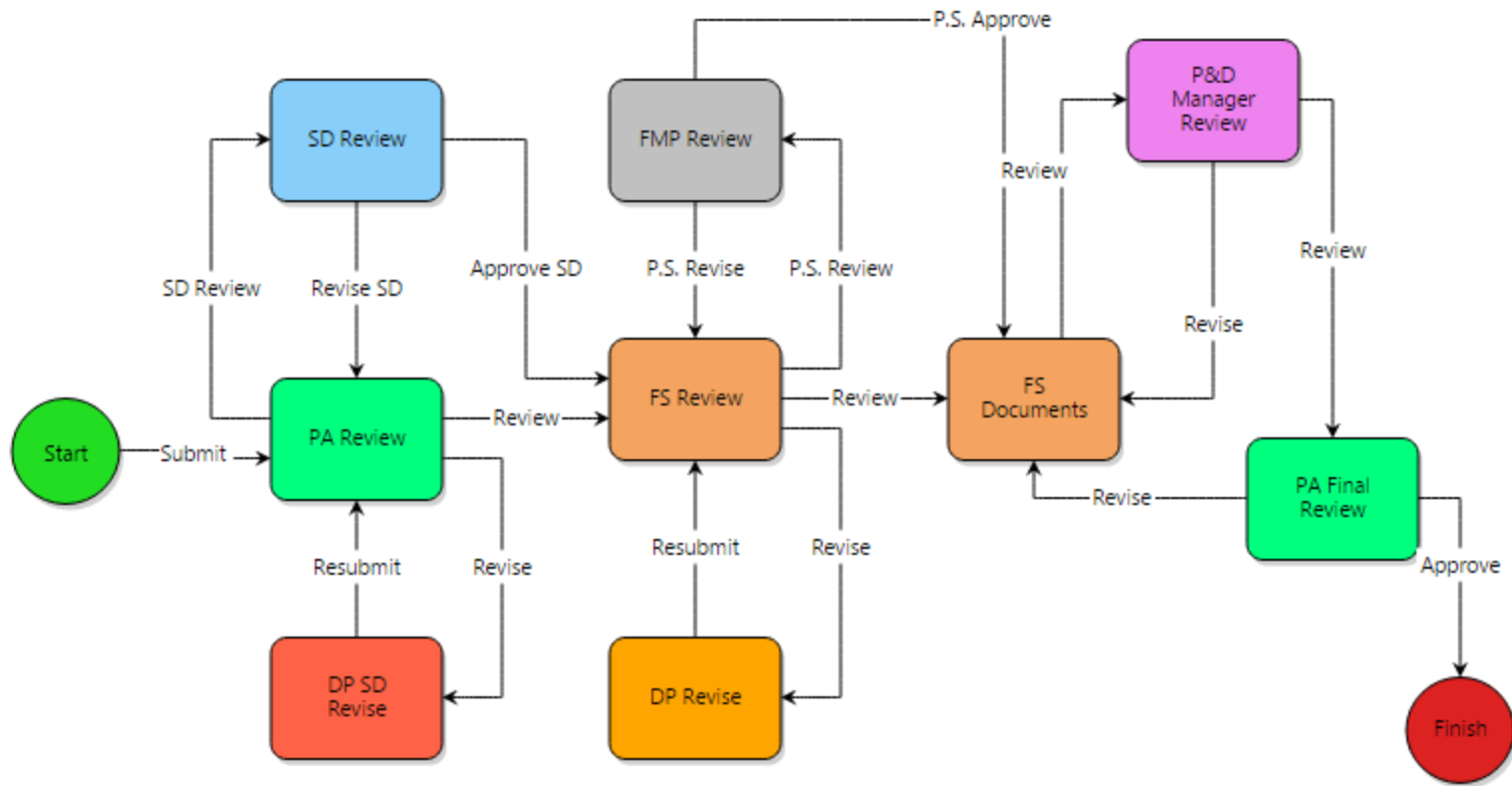

Schedule of Values

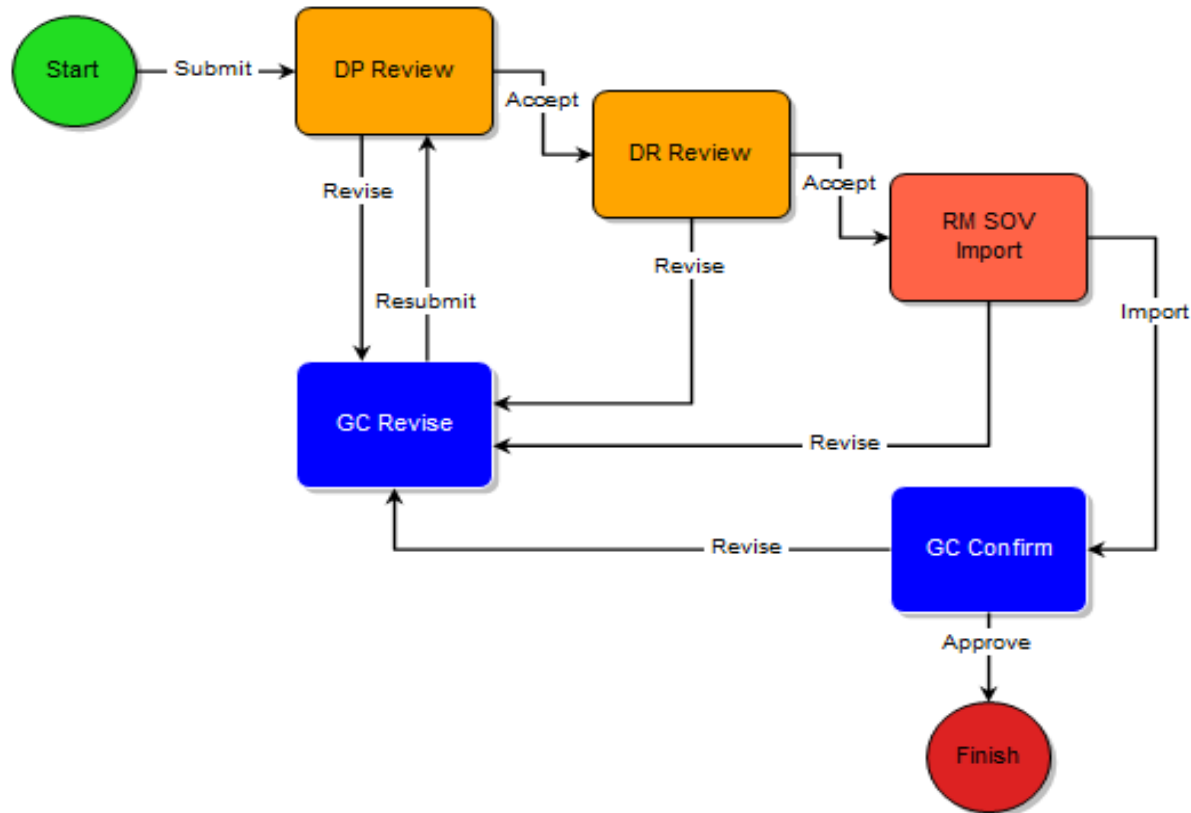

Request for Information

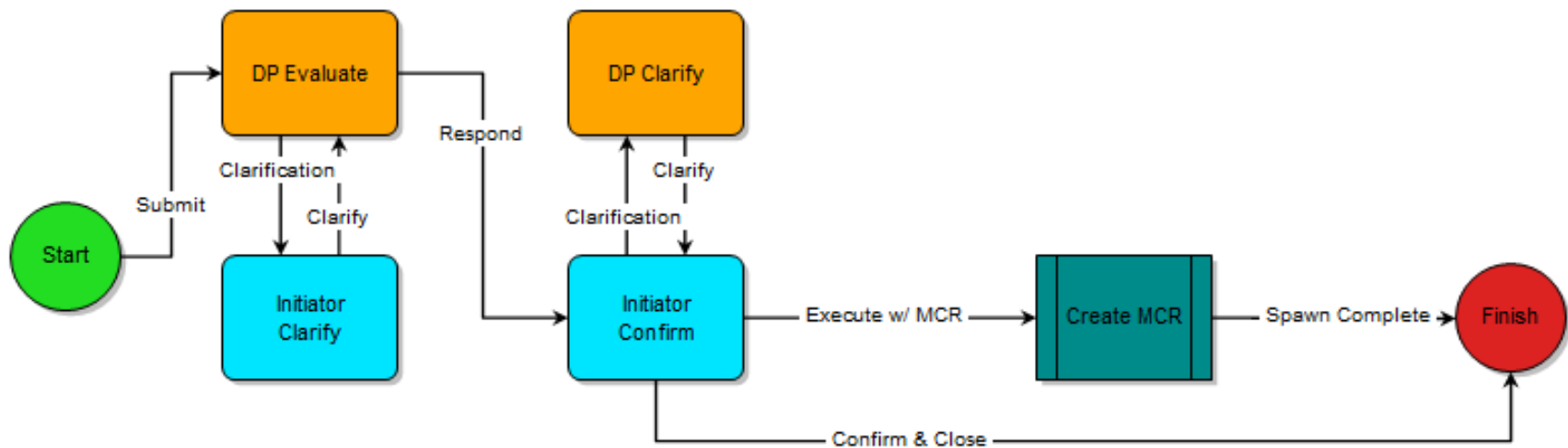

Architectural Supplemental Instructions

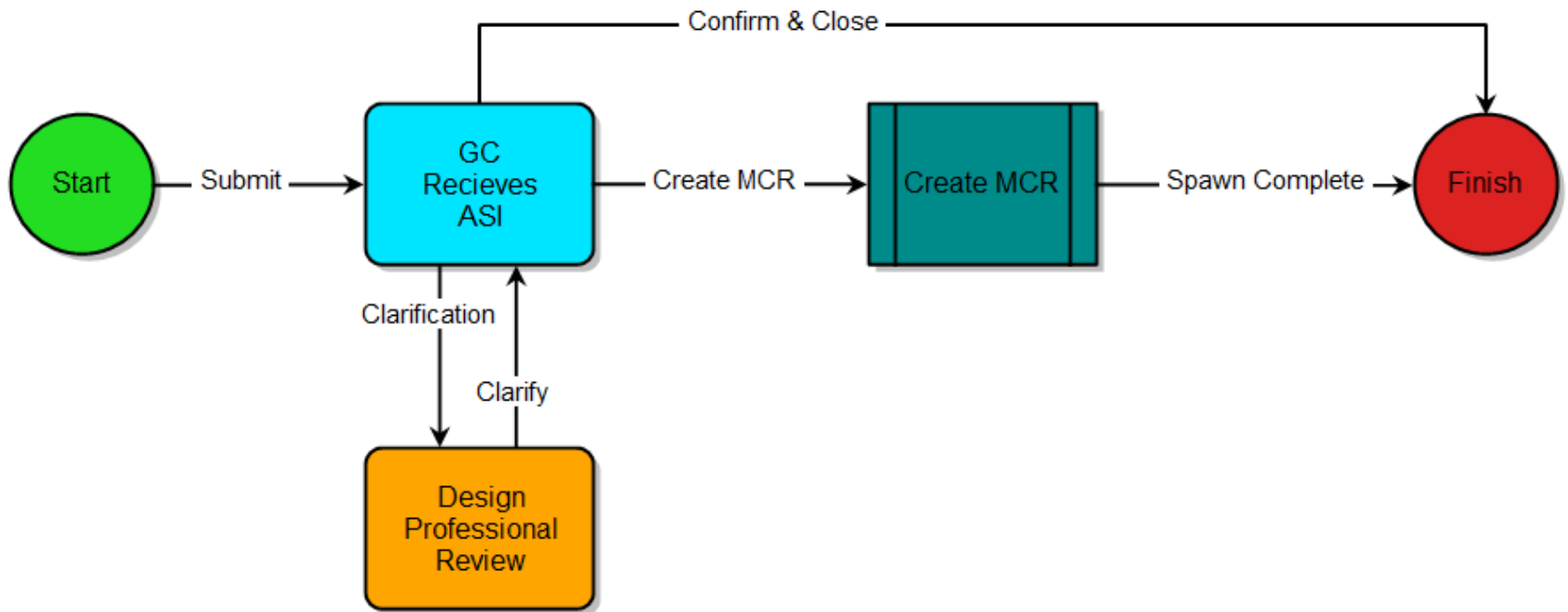

Additional Design Services Request

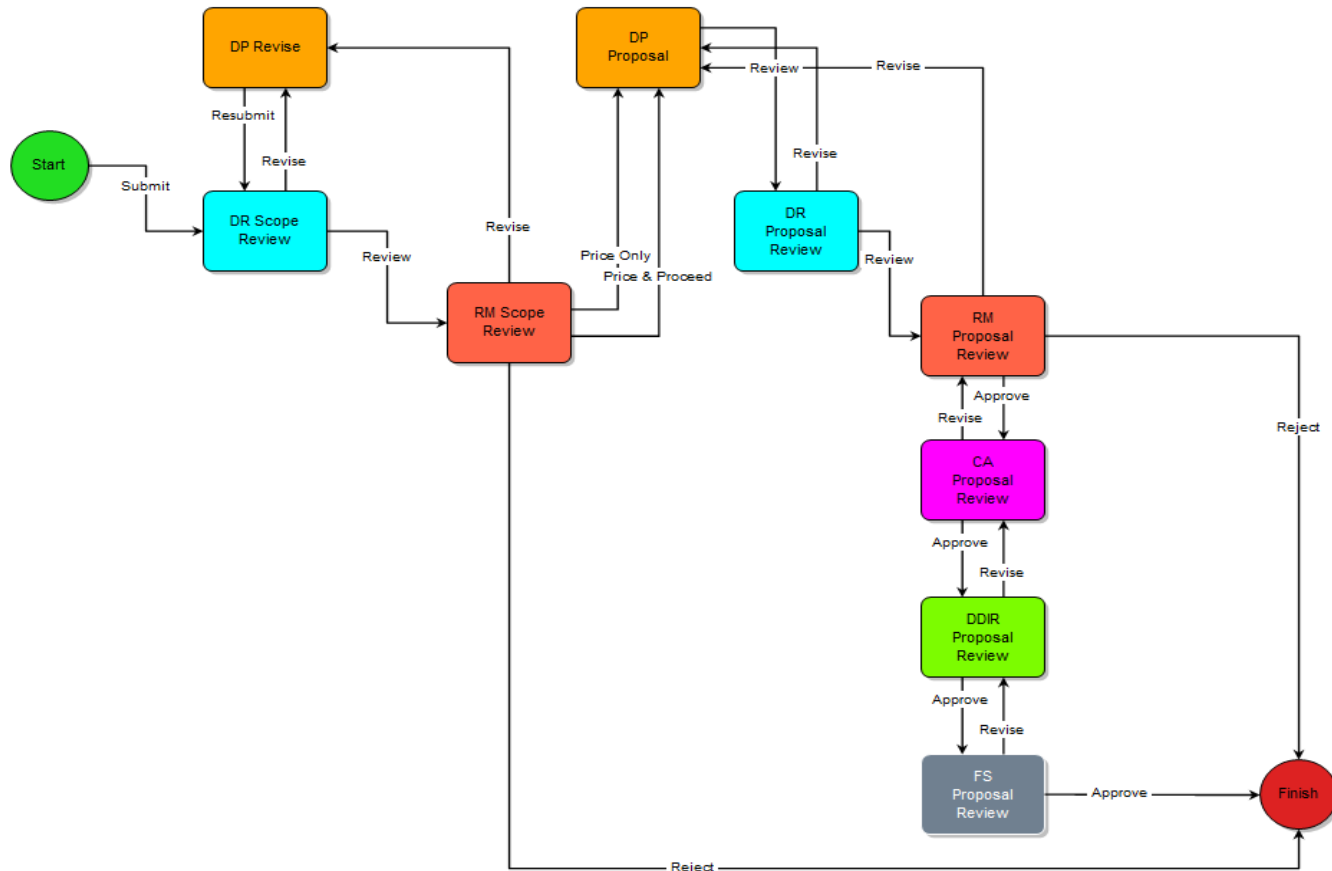

Modification Change Request

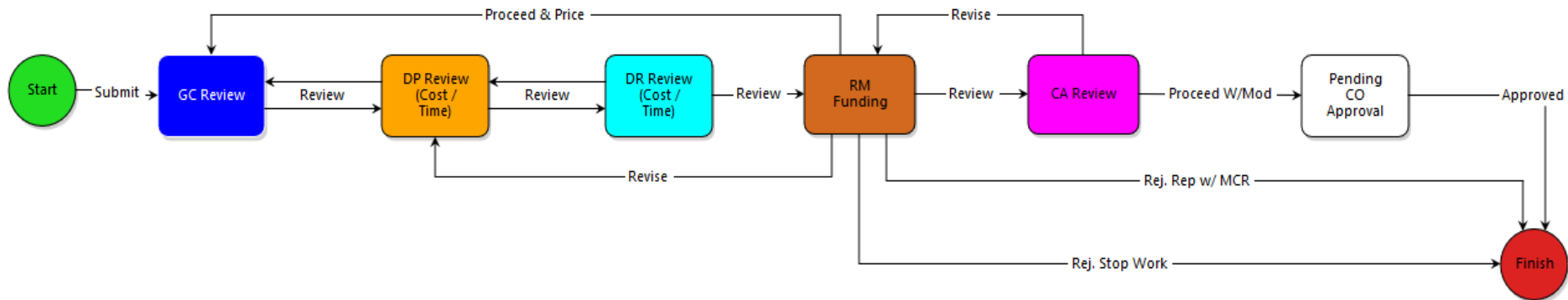

Change Order

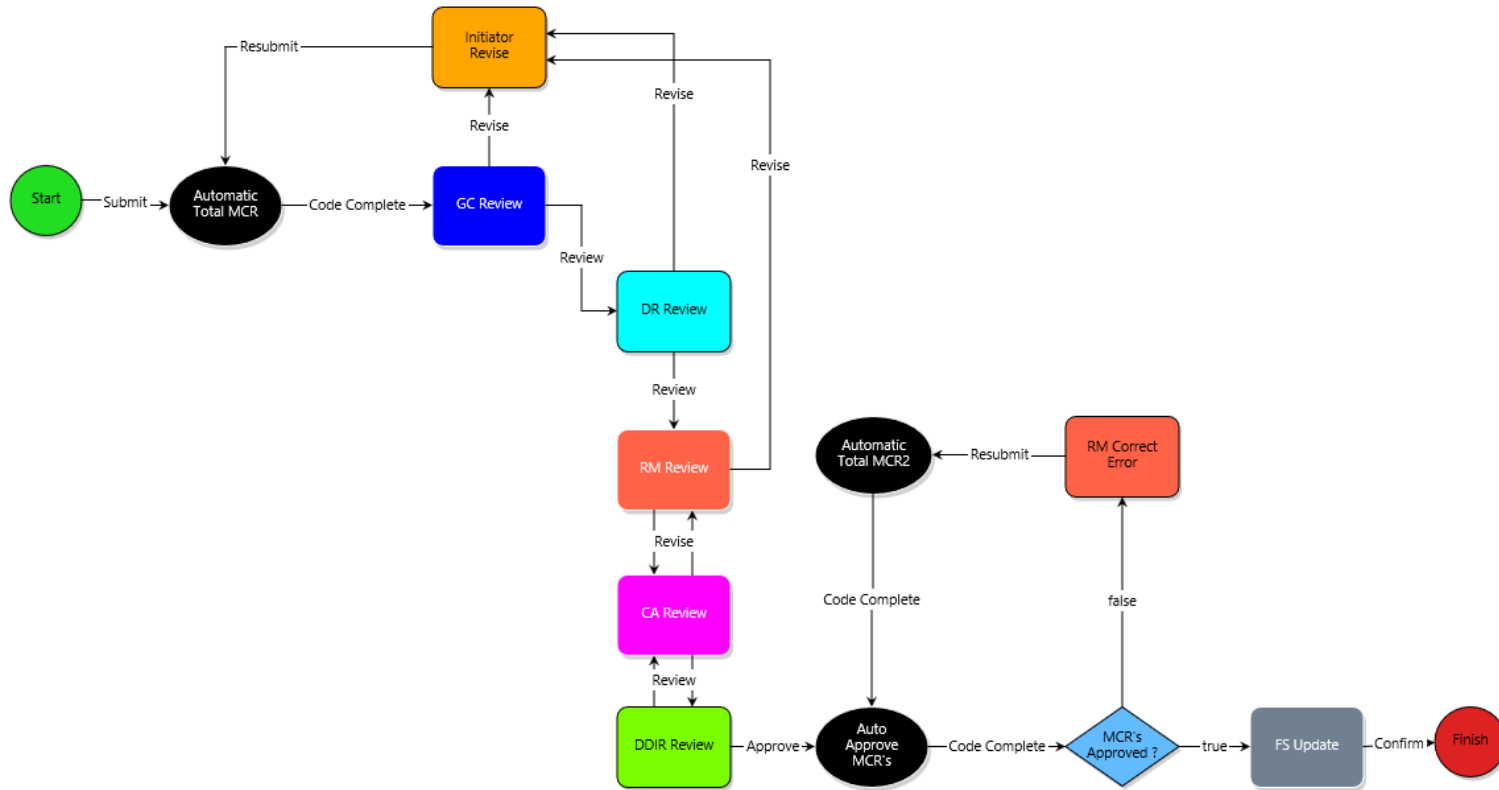

GC Pay Application

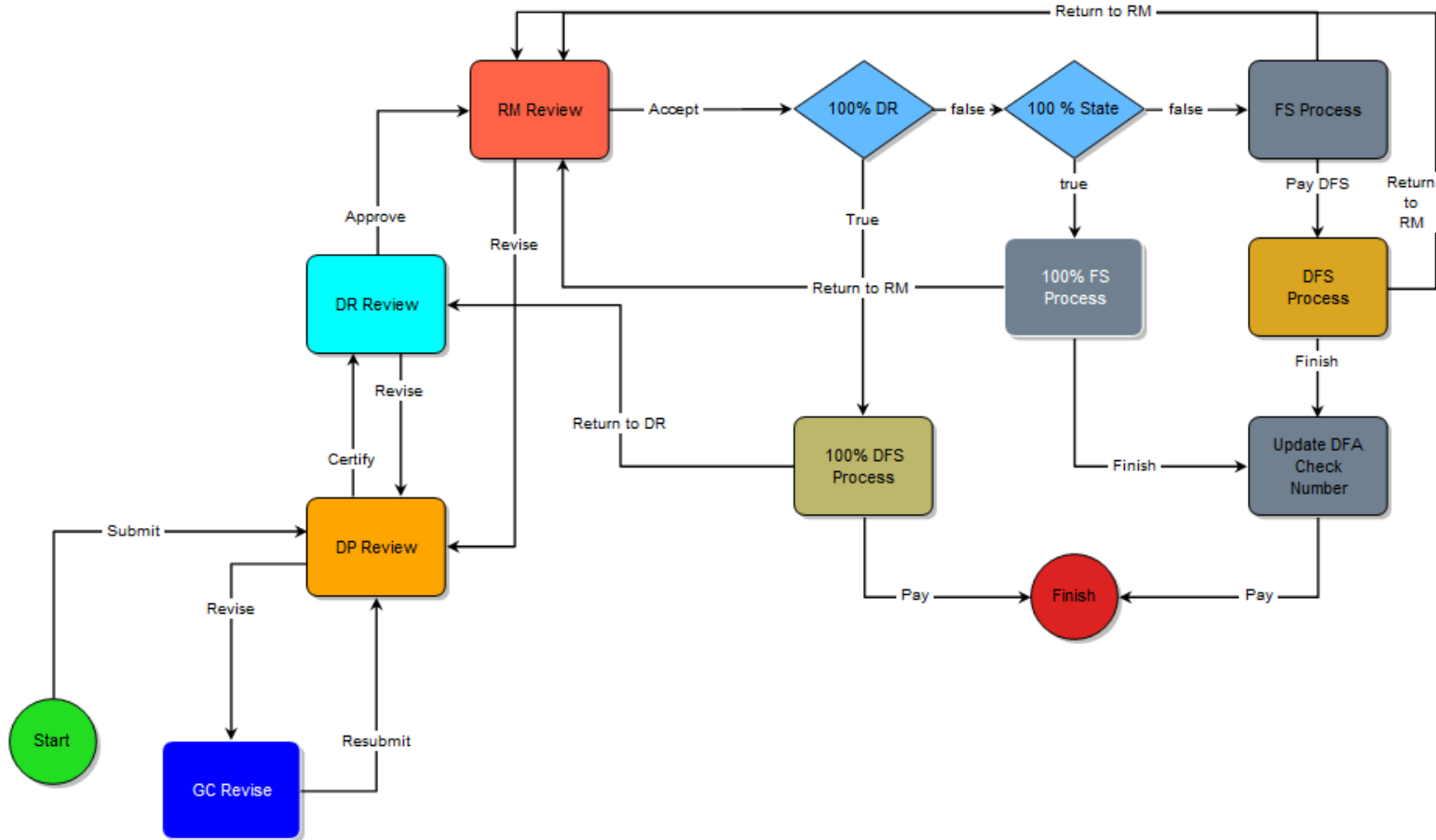

Vendor Invoice

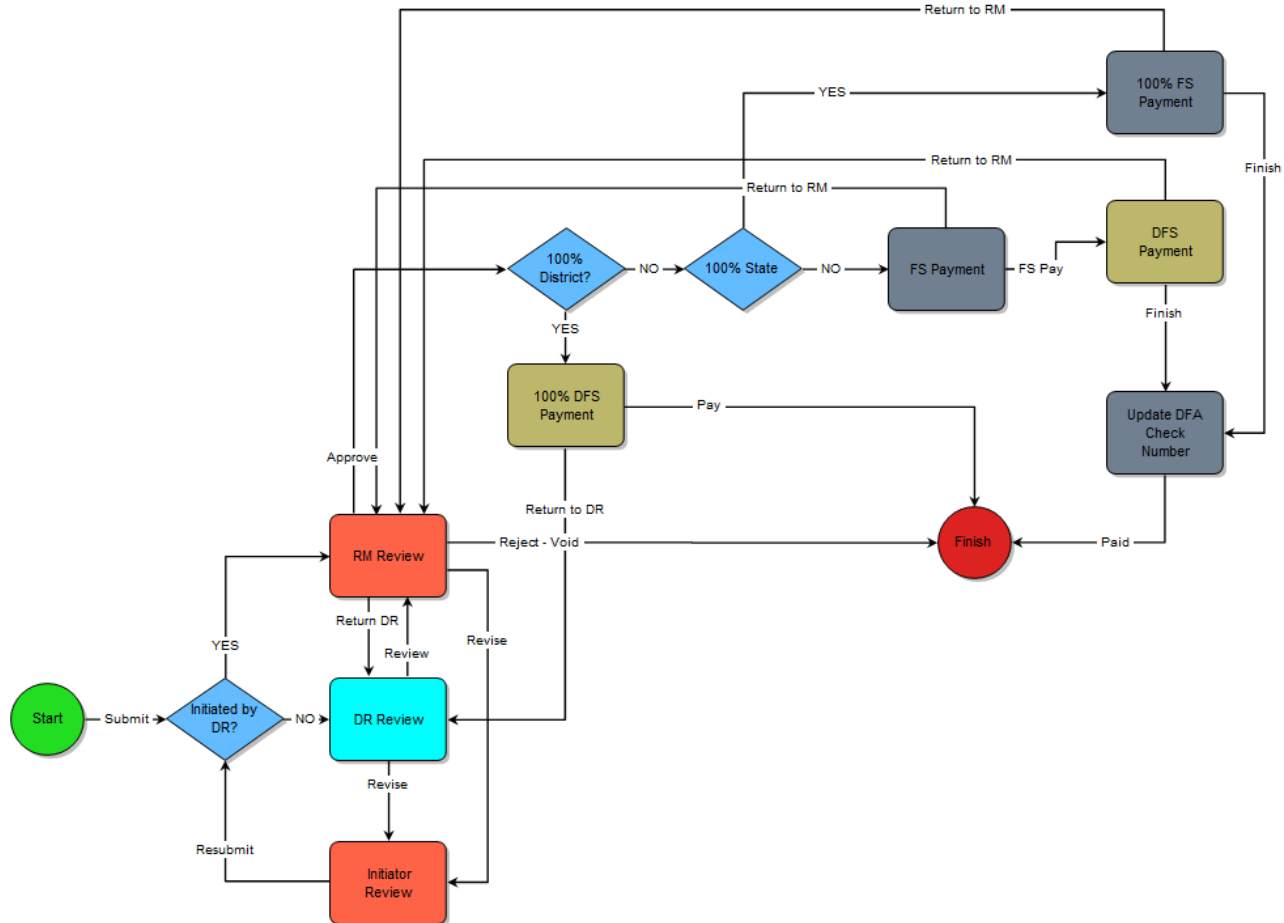

Substantial Completion

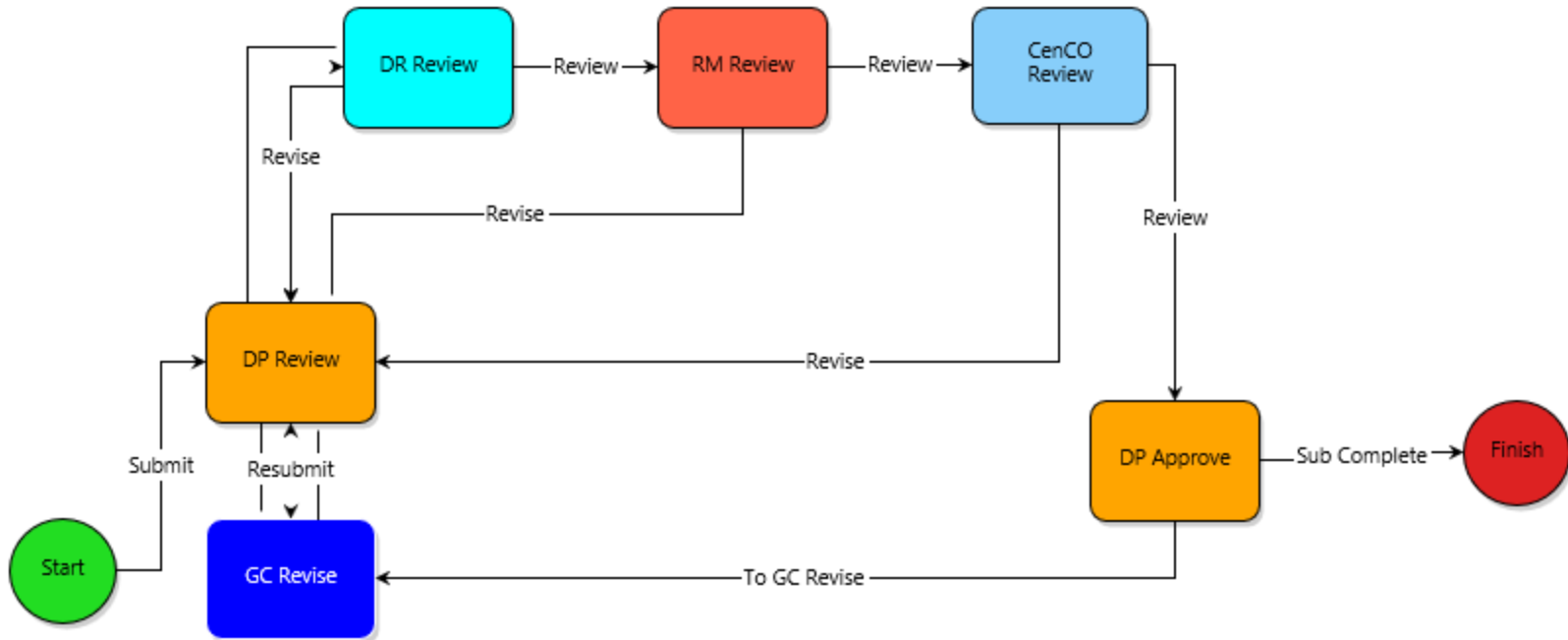

Document Closeout

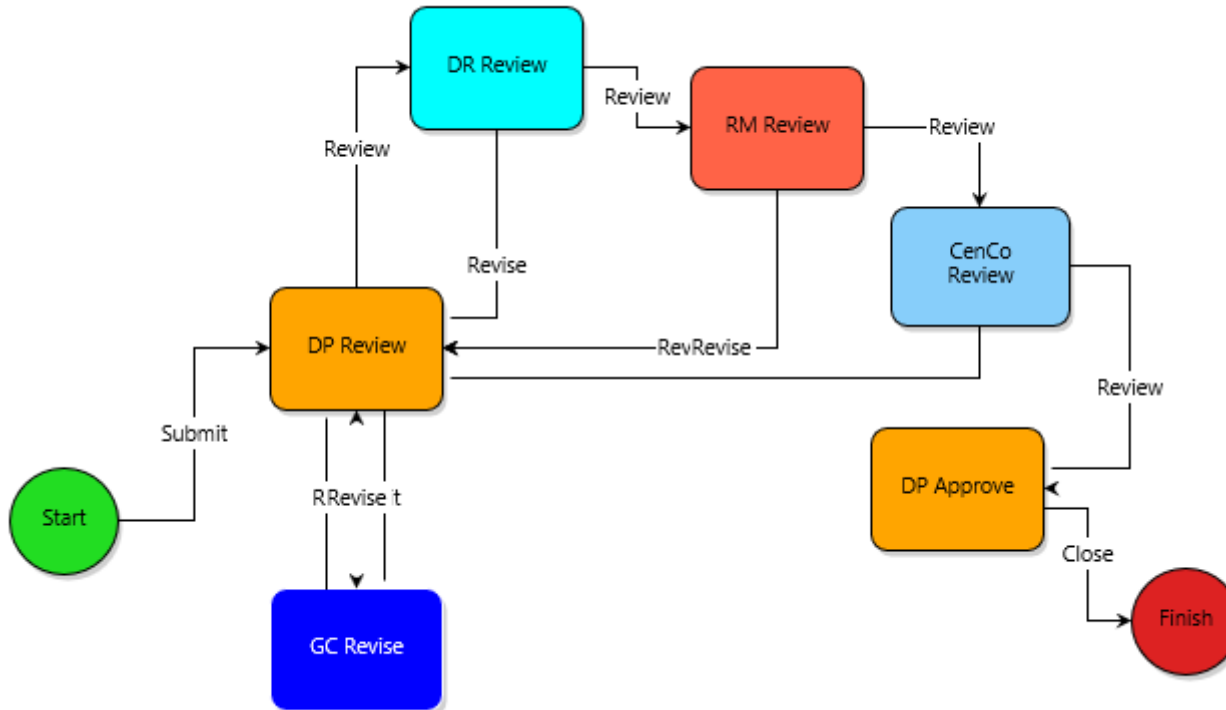

11 Month Correction

