

# Commitment Approval

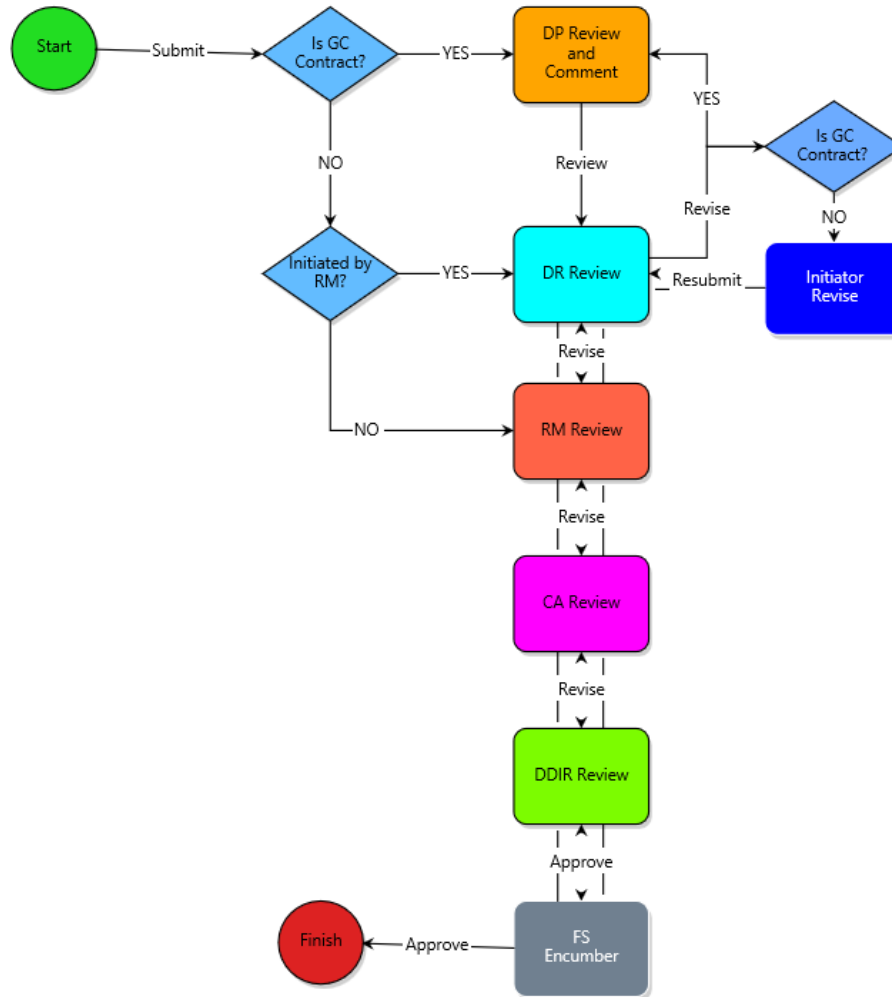

# Commitment Change

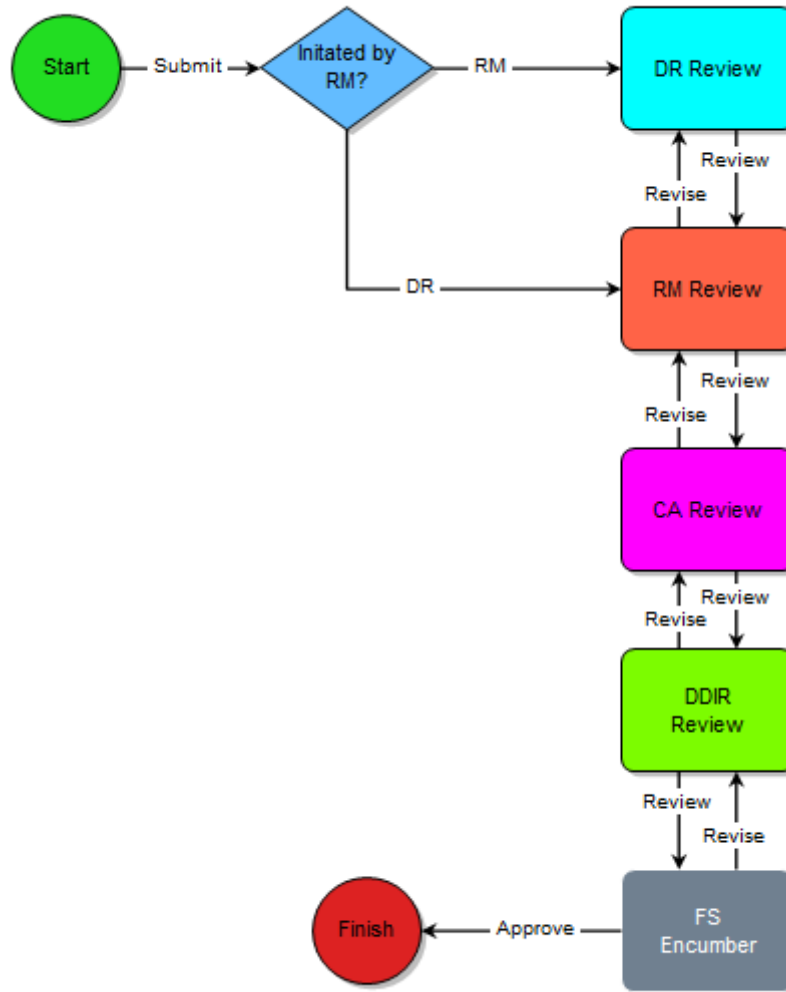

# Owner Design Review

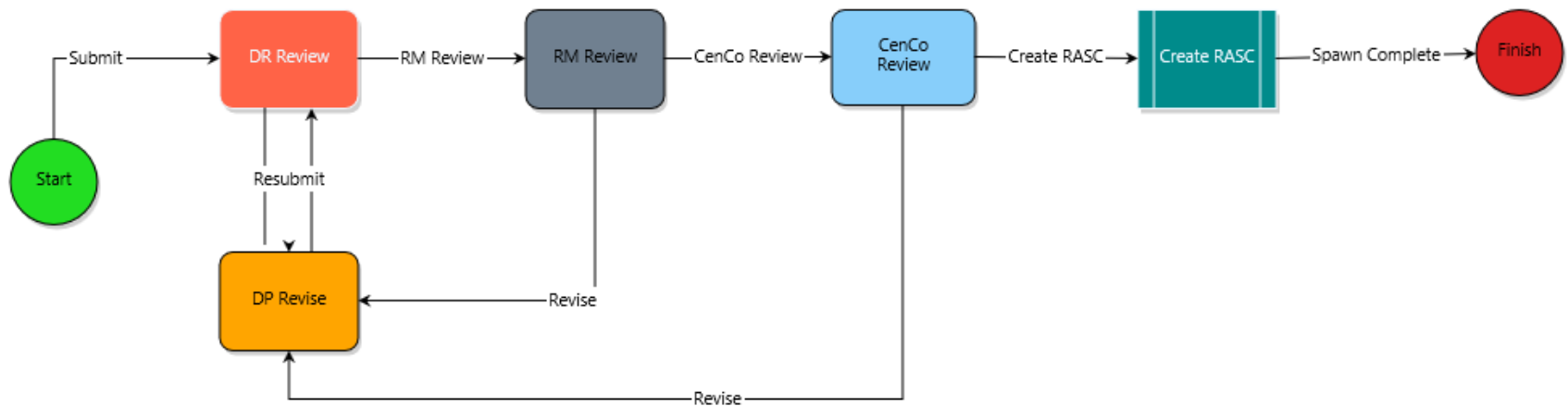

# Request for Approval of School Construction (PSCOC)

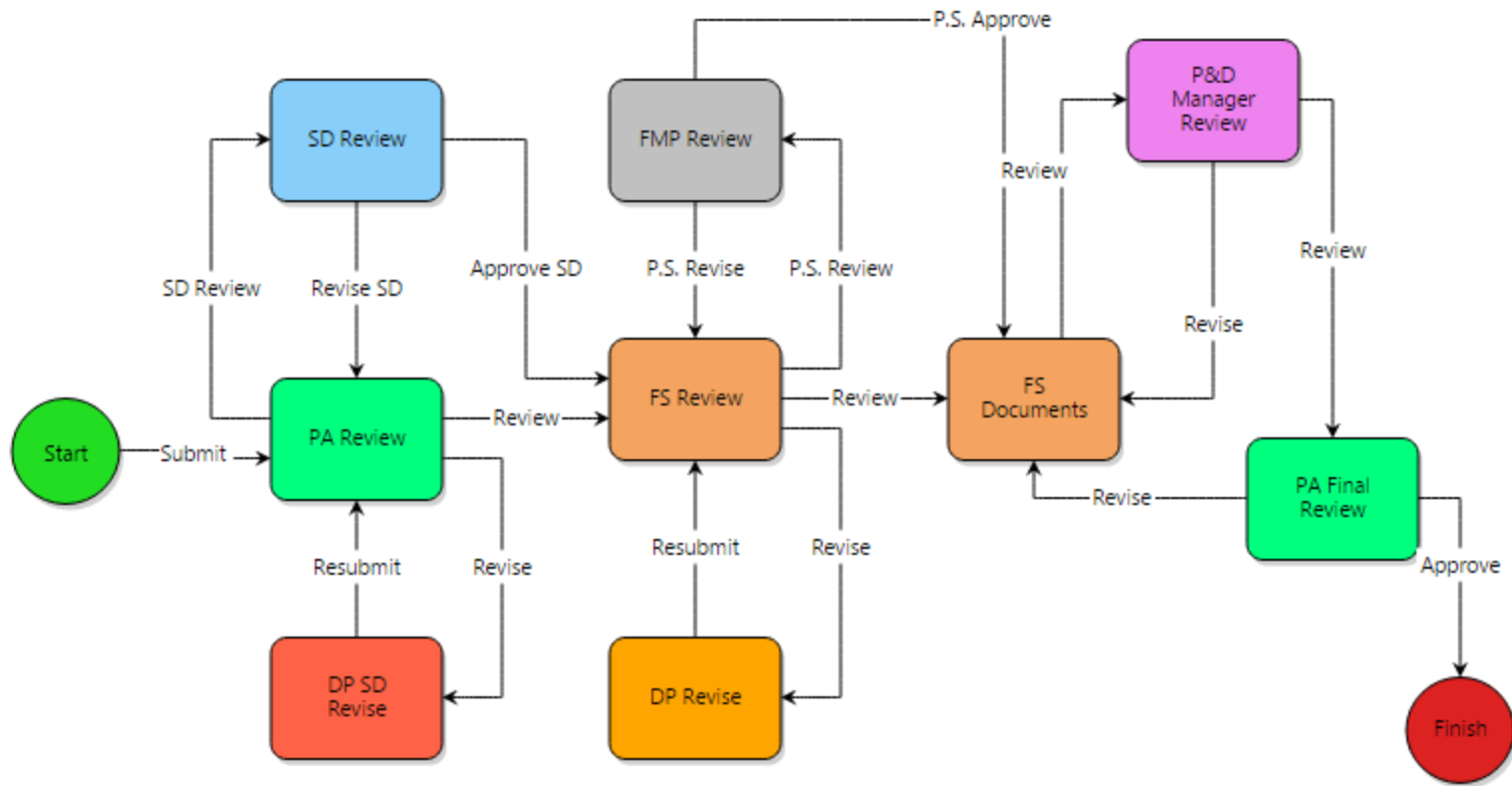

# Schedule of Values

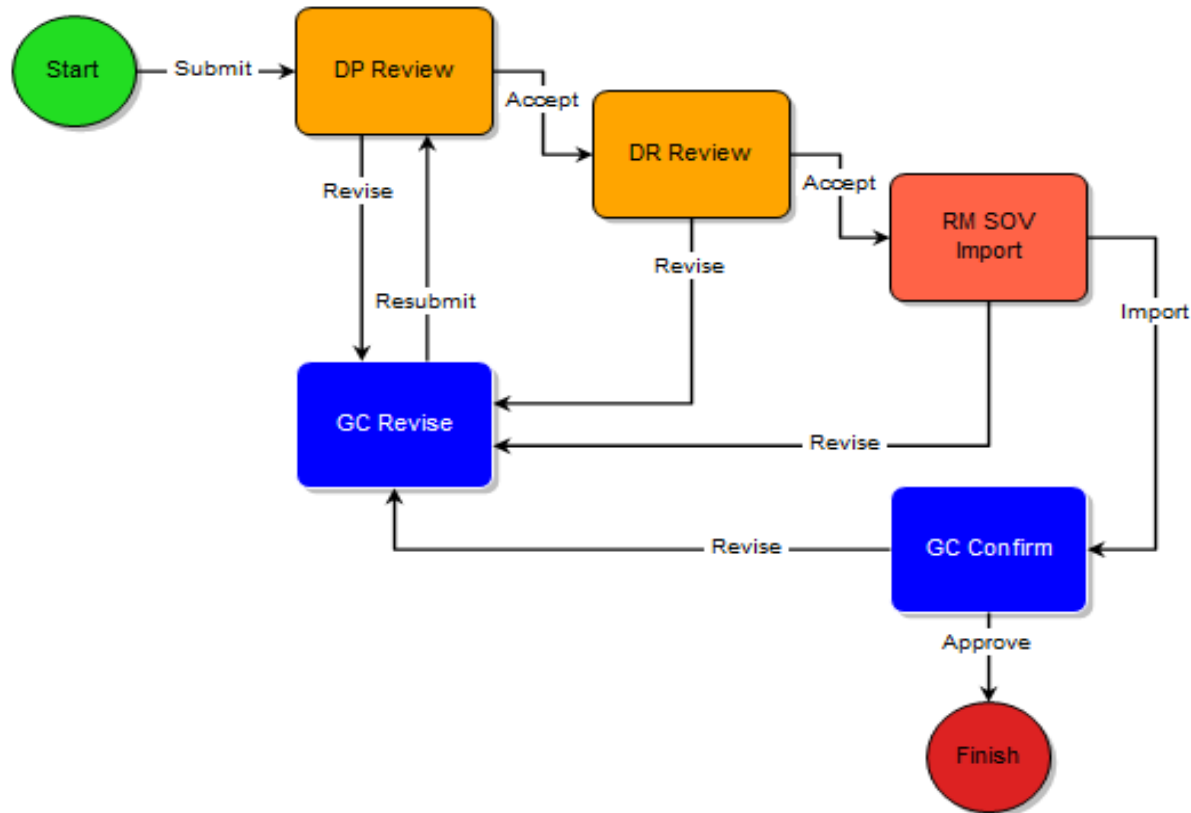

# Request for Information

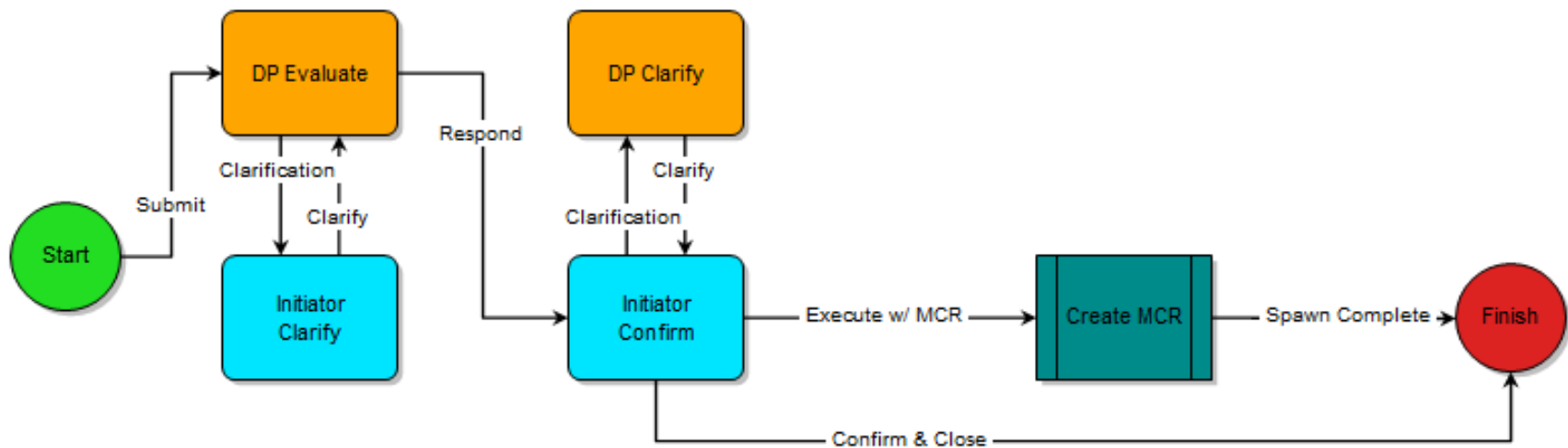

# Architectural Supplemental Instructions

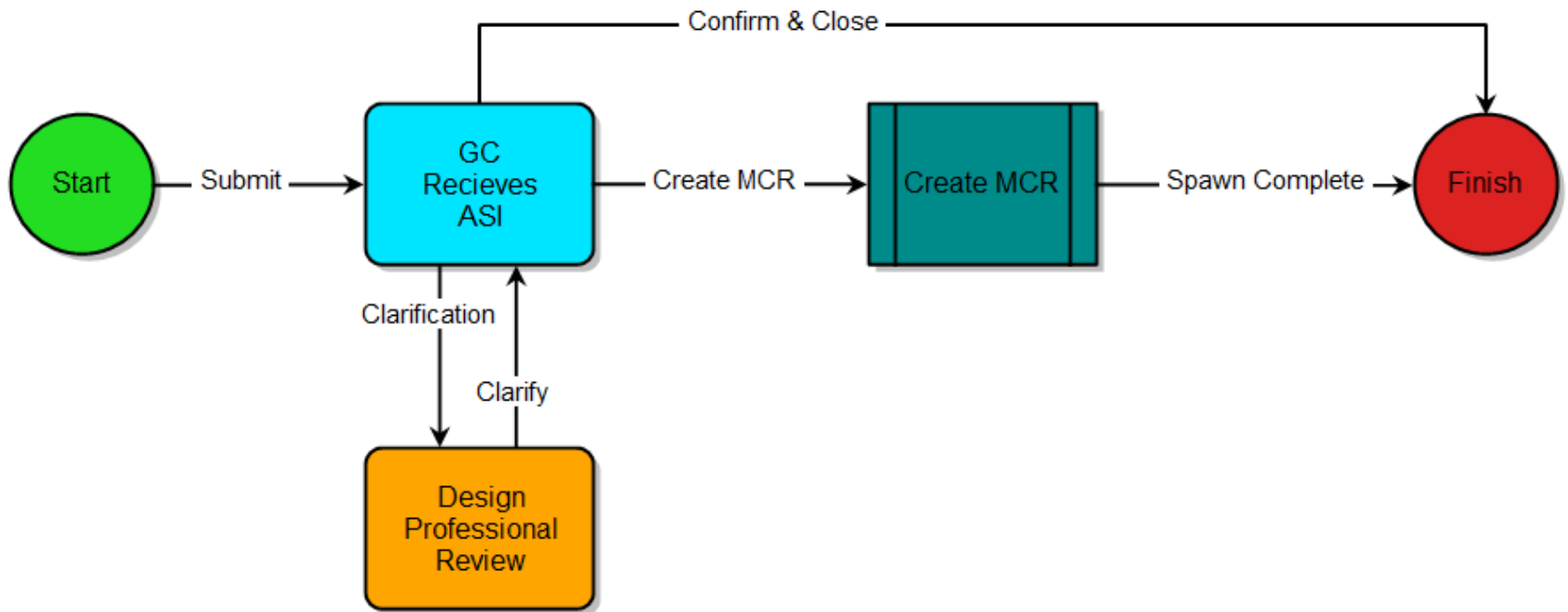

# Additional Design Services Request

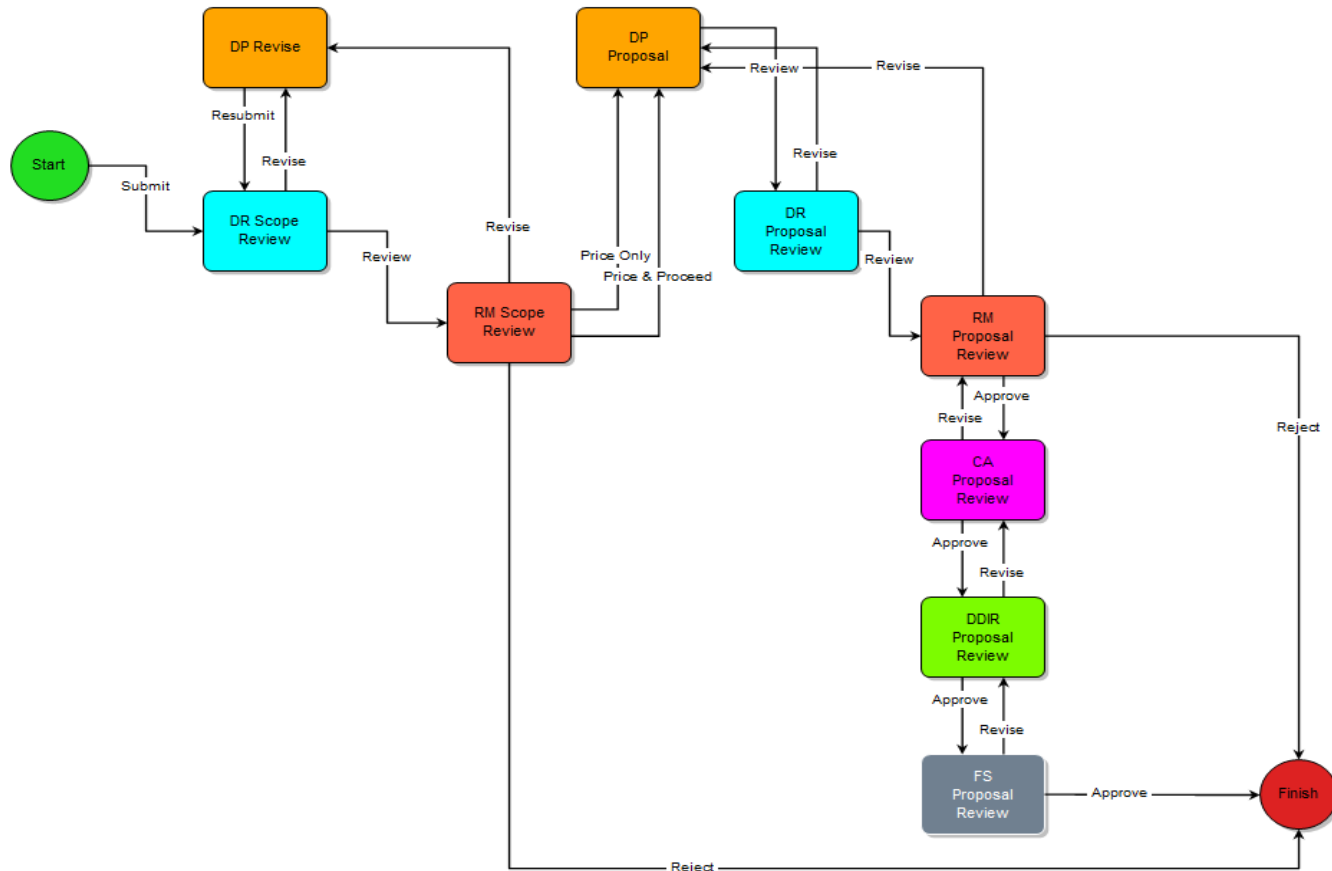



# Modification Change Request

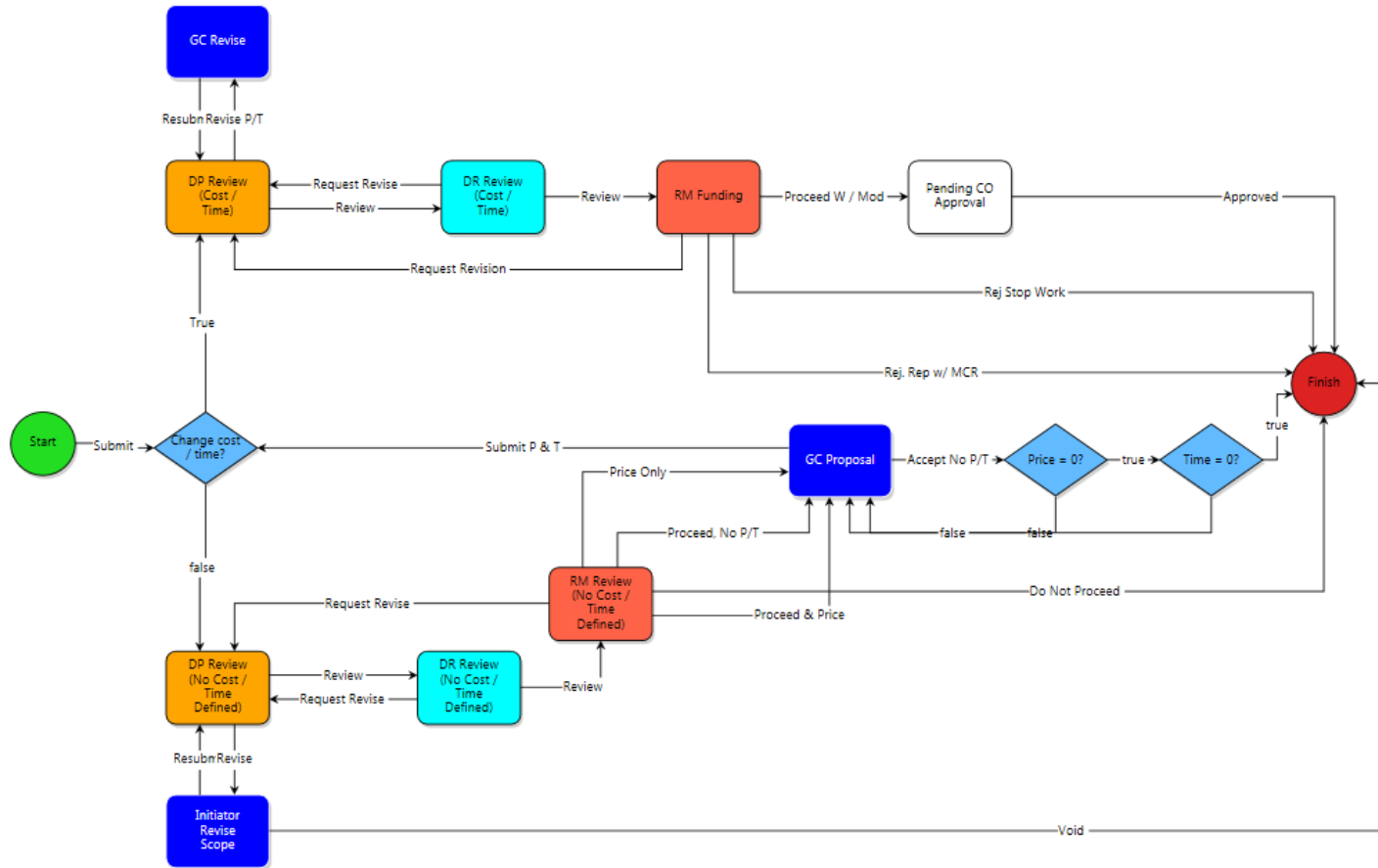

# Change Order

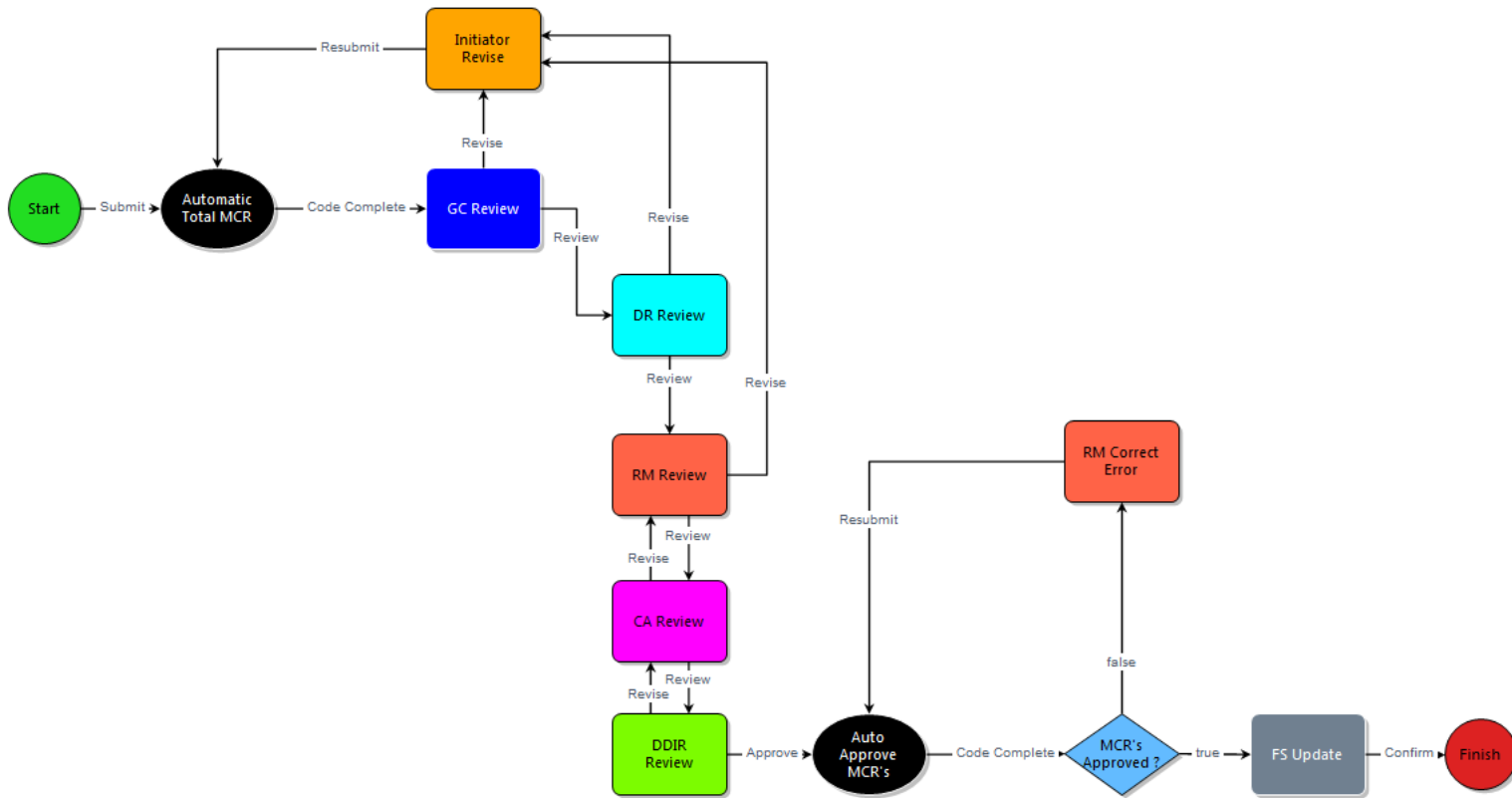

# GC Pay Application

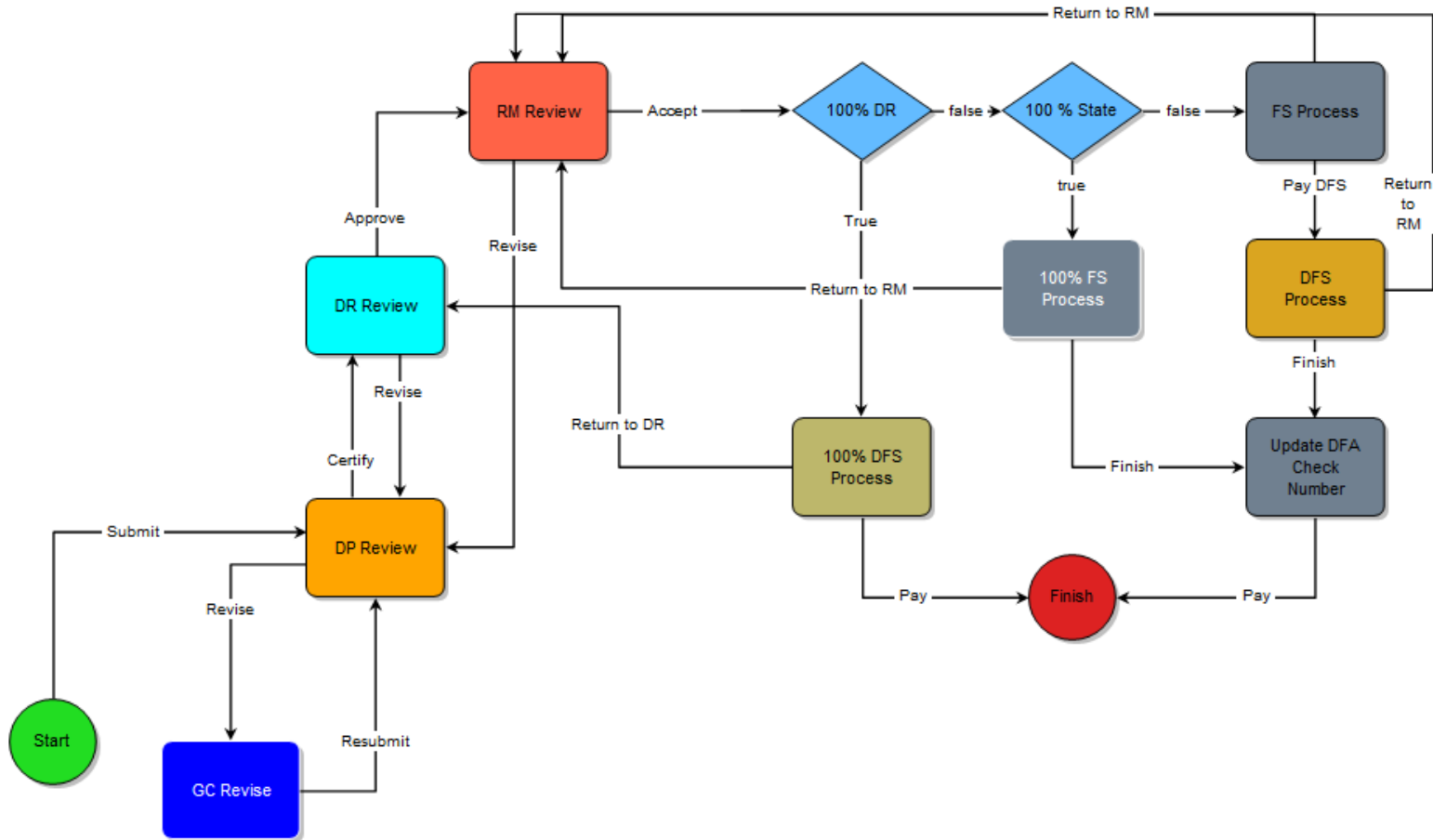

# Vendor Invoice

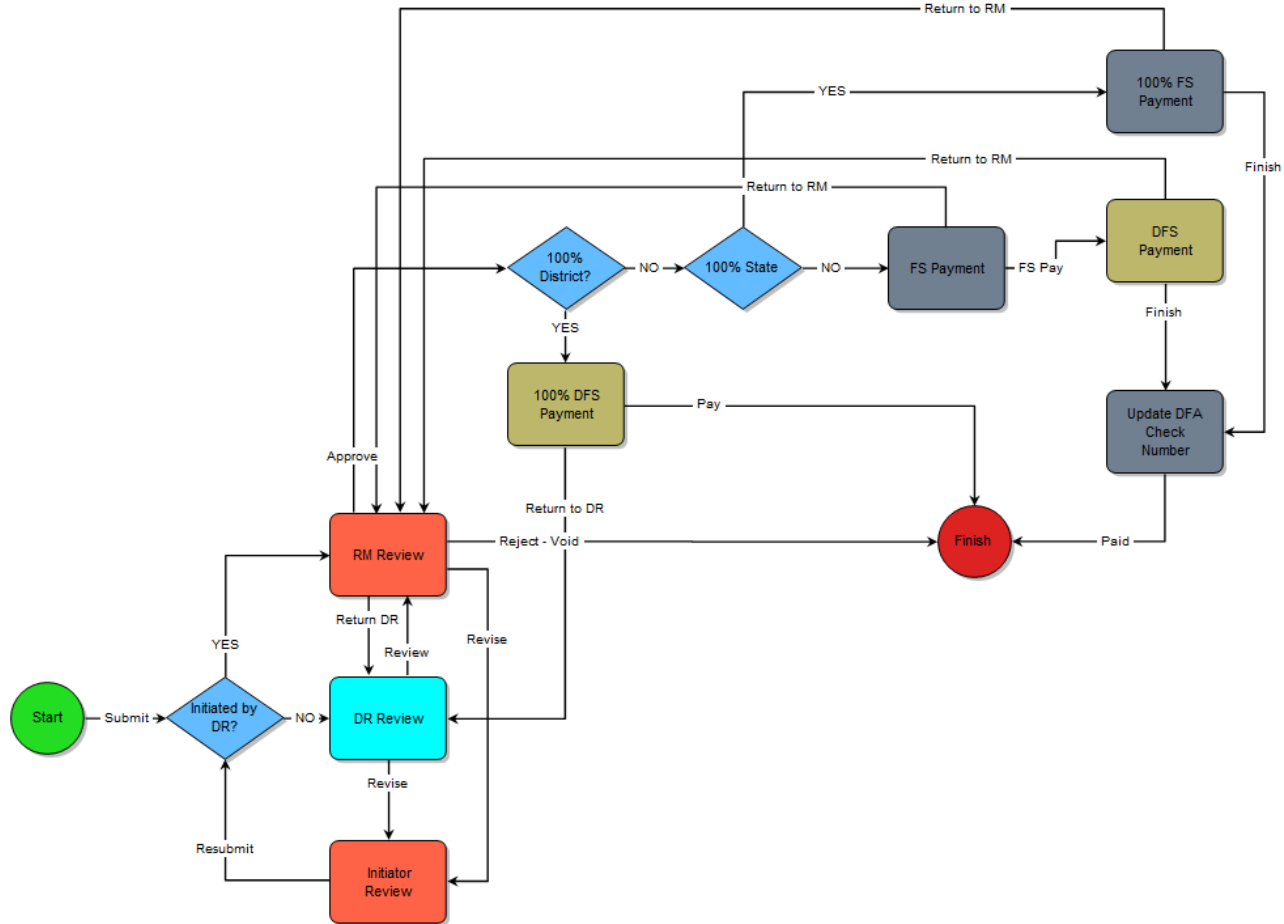

# Substantial Completion

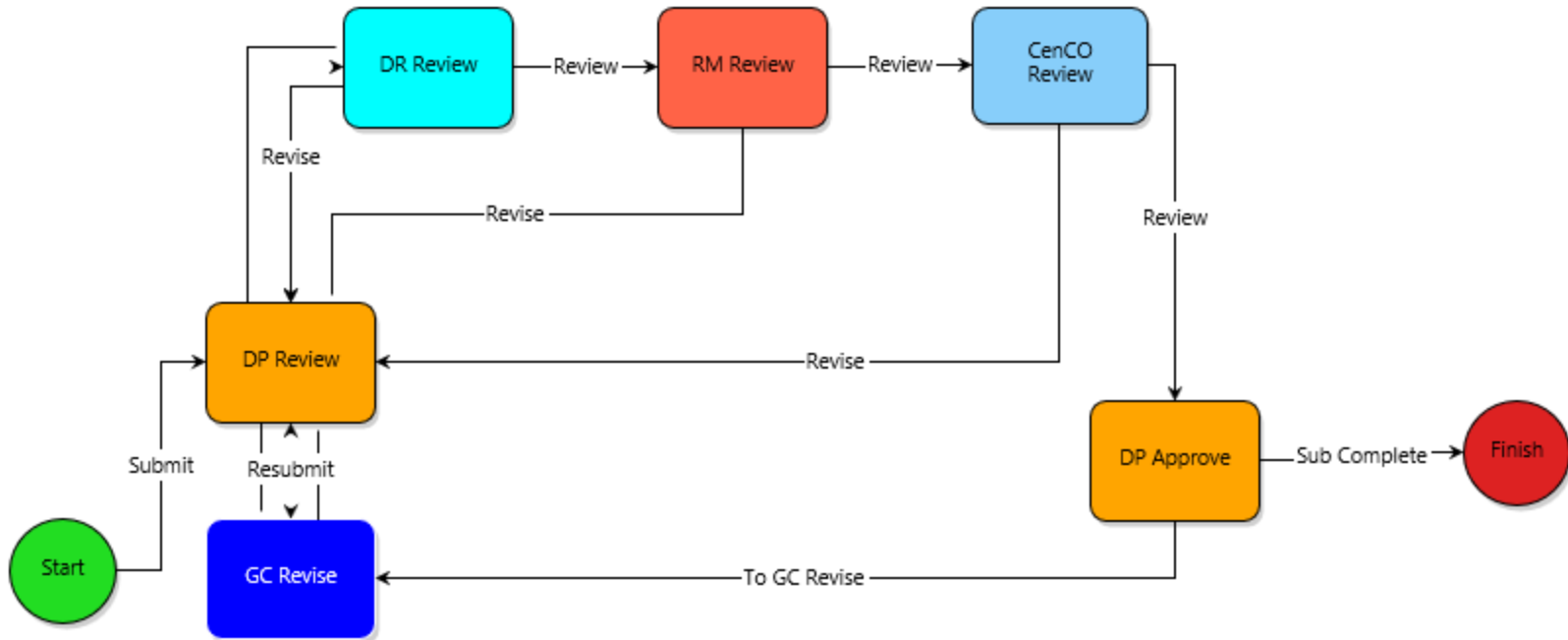

# Document Closeout

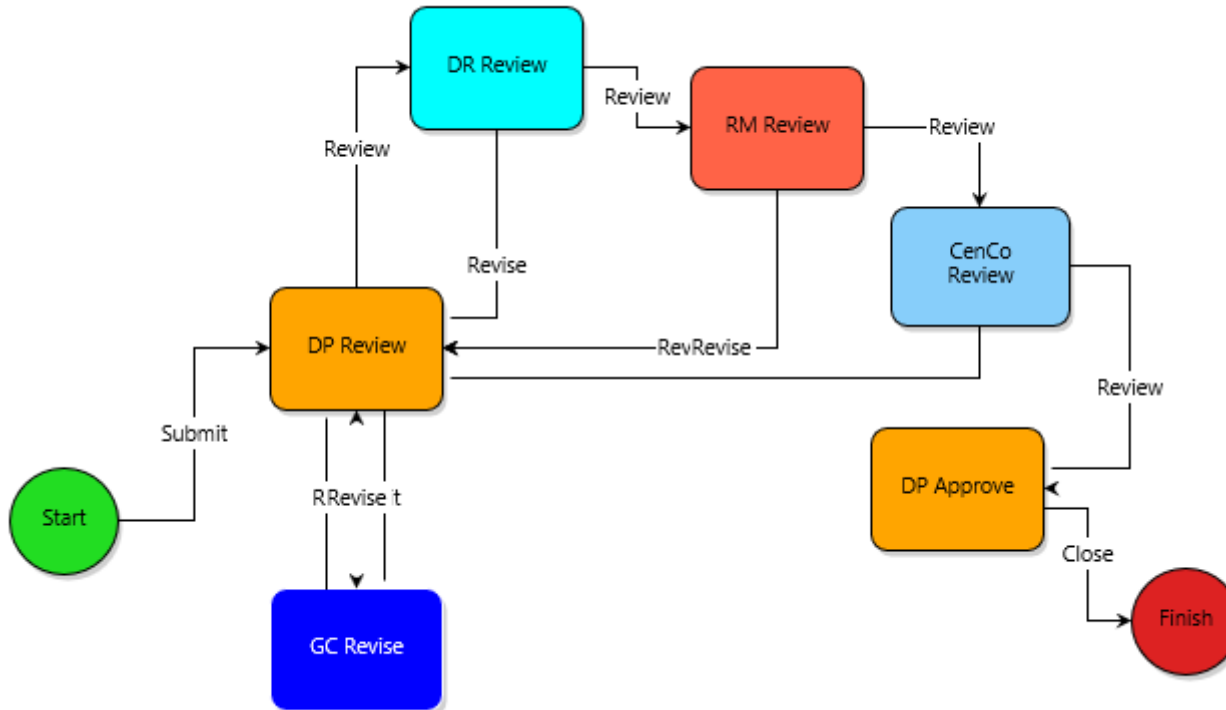

# 11 Month Correction

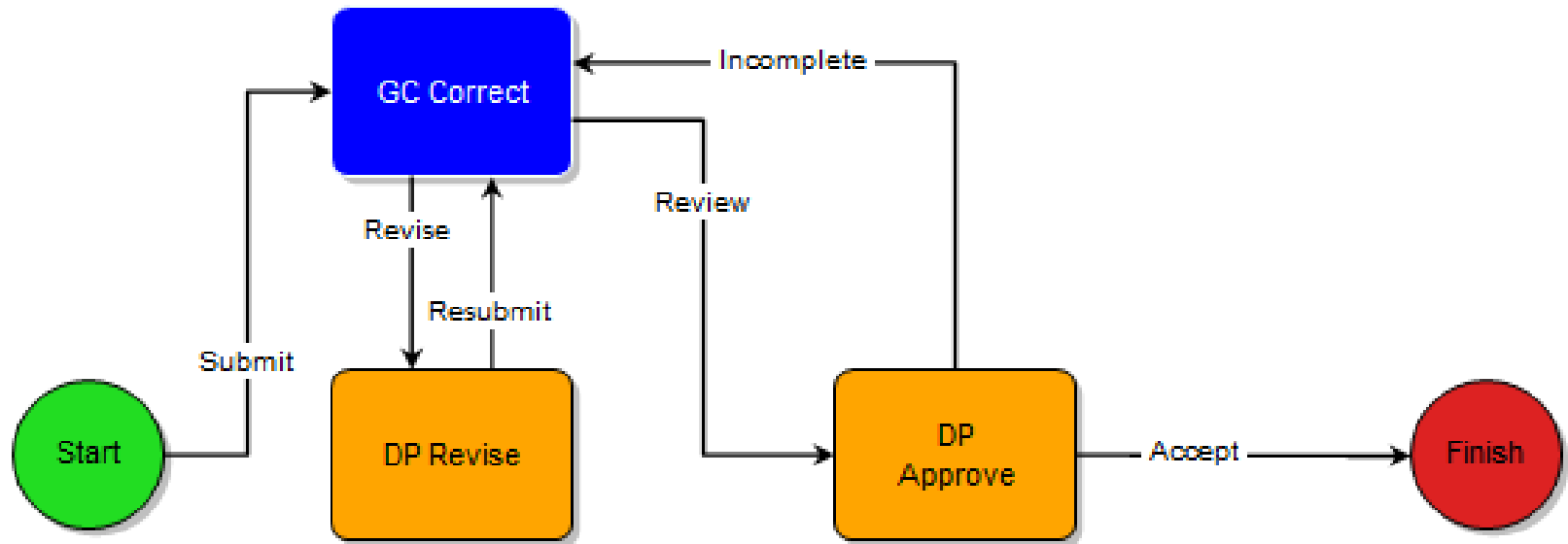

# Ed Spec Review

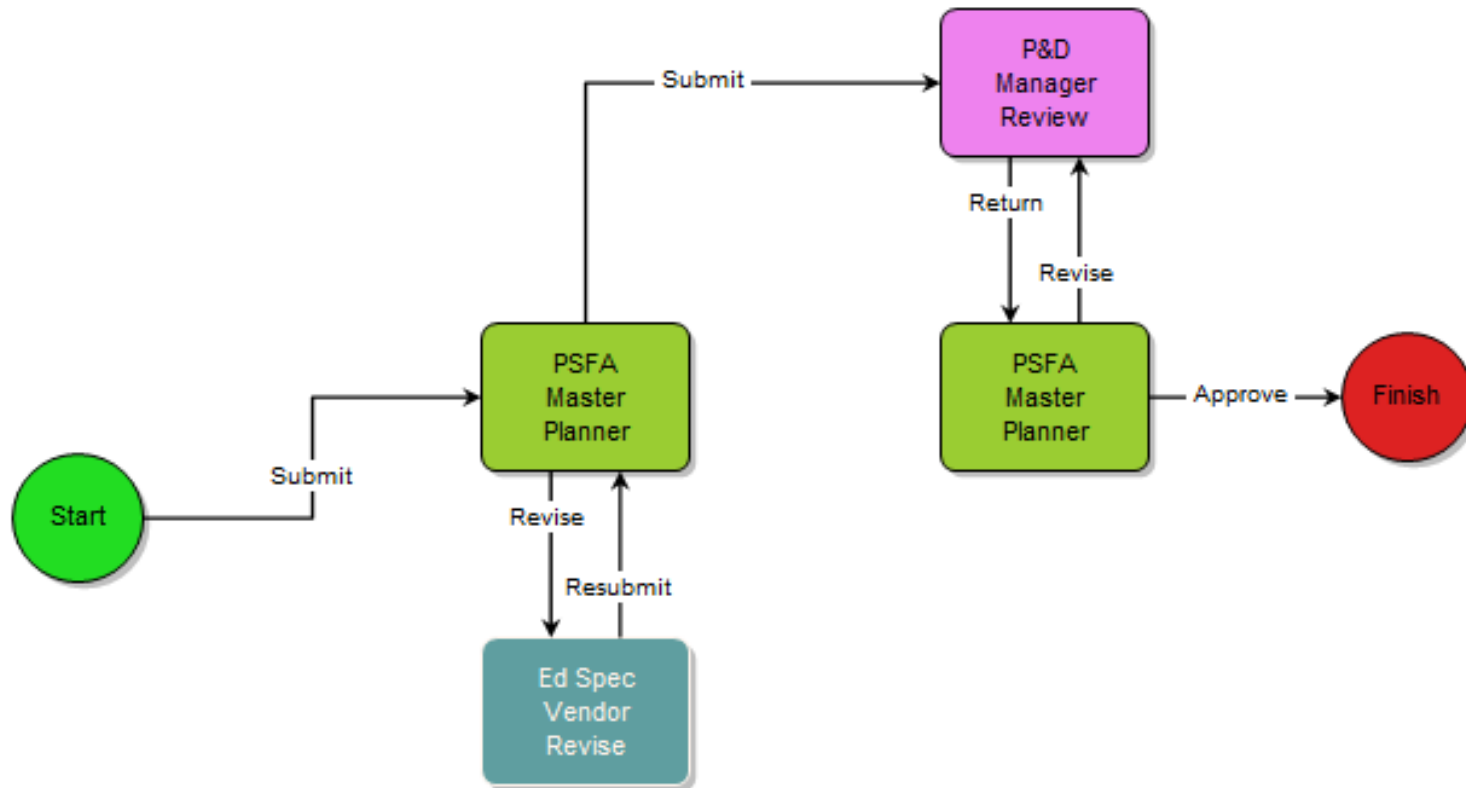



# Facility Master Plan Review

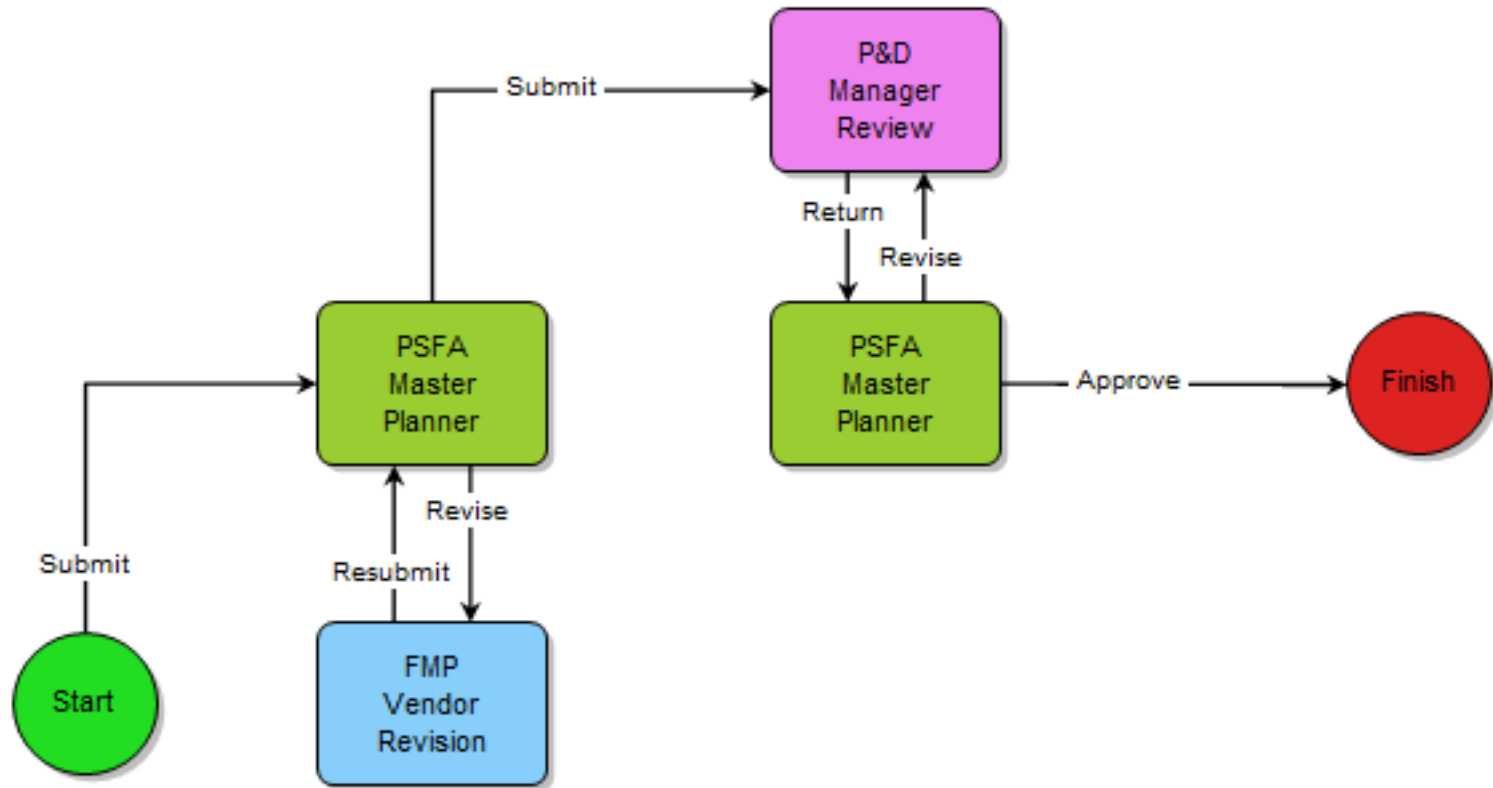

# Request for Approval of School Construction (non-PSCOC)

